

















## Preface

Interior finishing materials are expected to have different functions like durability, safeness, comfort, etc., according to the roles and functions required for each individual room.

Technical description here indicates our recommendation of the most suitable flooring for each area with various test results and evaluations conducted by TOLI.

### Technical data INDEX

	<b>Anti-viral performance</b>	of Vinyl Sheets, tiles, Wallcoverings & Dadoes	p.1
	<b>Antibacterial Performance / Antifungal Performance</b>	of Vinyl Sheets, Tiles, Skirtings & Dadoes	p.2
	<b>Antibacterial Performance / Bacteriostatic Performance</b>	of Carpet Tiles, Curtain Fabrics & Wall Coverings	p.3
	<b>Ease of Maintenance</b>	of Vinyl Sheets & Tiles	p.4
	<b>Chemical Resistance</b>	of Vinyl Sheets & Tiles	p.5~7
	<b>Slip Resistance</b>	of Vinyl Sheets, Tiles & Carpet Tiles	p.8~9
	<b>Impact-Absorbent Property</b>	of Vinyl Sheets, Tiles & Carpet Tiles	p.10
	<b>Antistatic Property</b>	of Vinyl Sheets, Tiles & Carpet Tiles	p.11~12
	<b>Durability against rolling loads</b>	of Vinyl Sheets & Tiles	p.13
	<b>Durability against static loads</b>	of Vinyl Sheets, Tiles & Carpet Tiles	p.14
	<b>Abrasion resistance</b>	of Vinyl Sheets, Tiles & Carpet Tiles	p.15
	<b>Caster-moving smoothness</b>	of Vinyl Sheets, Tiles & Carpet Tiles	p.16
	<b>Noise reduction &amp; Sound-Insulation Properties</b>	of Vinyl Sheets, Tiles & Carpet Tiles	p.17



# Anti-viral performance of Vinyl Sheets, tiles, Wallcoverings & dados



Data below will help you to organize hygienic space as the guidance about performances of interior finishing materials.

Anti-viral property of floor covering will play a supplementary role to prevent the growth of viruses, and to achieve more hygienic environment. Anti-viral agents kneaded into surface layer will give the flooring a function of reducing specific viruses by 99% or more.

## Anti-viral performance

			Antibacterial criteria (Antibacterial Active Value: $\geq 2.0$ )	
Category	Product name	Thickness (mm)	Anti-viral active value	SIAA Certification Label
Vinyl sheet	CF SHEET-H	1.8	 2.0 or over (virus with envelope) 	
	CF SHEET-SD	3.5		
	CF SHEET-P NW	2.3		
	FLOORLEUM PLAIN NW	2.0/2.5		
	FLOORLEUM MARBLE NW	2.0/2.5		
	FLOORLEUM PREMIER NW Series <sup>*1</sup>	2.0		
	HITOE GRANZA/FINE	2.0		
	NONWAXLEUM NW	2.0		
	MATURE NW	2.0		
	DEODORANT NS TOWARE NW	2.0		
	HOSPILEUM NW	2.0		
	SF FLOOR NW	2.8		
	CARESAFE NW	4.5		
ARENA FIT	4.5			
腰壁	TOLI STAIN-RESISTANT DEODORANT KOSHIKABE SHEET (Dado)	1.0		
Tiles	LAYFLOORING PITAFI	2.0	 2.0 or over (with/without envelope) 	
	TOUGHTTEC TILE	3.0		
	E-CLEAN NW-EX	3.0		
	LOOSELAY MASTER NW-EX	5.0		
	LOOSELAY 50NW-EX	5.0		
LOOSELAY 40NW-EX	4.0			
Wall covering	ANTI-VIRAL WALL COVERING POWER1000 VS	—	2.0 or over (virus without envelope)	VS
	REAL DECO	—	2.0 or over (with/without envelope)	

\*1 series consists of FLOORLEUM SOILUD NW, LATTICE NW, FLAKE NW, NATTY NW.

[Criteria for Evaluation] to be Judged as anti-viral: Anti-viral activity value of **2.0 or higher** for either or both virus types with and without envelope.

### ● Test Method

Antiviral test (ISO21702 method)

Two type samples are prepared in a 50mm square size: One is "processed products" with antiviral treatment and another is "unprocessed products" without antiviral treatment. Inoculate each test sample with 0.4 ml of viral solution, cover it with a coating film, and keep it at 25±1°C & 90%RH or higher for 24 hours. Then, the viruses are collected from the test samples, and the viral transmission value is measured by the plaque method. The test results are evaluated as an antiviral activity value by comparing the number of viruses on the processed product and those on the un-processed product.

### SIAA Certification



- SIAA marking is indicated on products that have been quality-controlled and such information been disclosed in accordance to the guidelines of the Antimicrobial Products Engineering Council based on the results evaluated by ISO21702 method.
- Complies with SIAA safety standards.
- Reduce the number of specific viruses on the product.
- Anti-viral processing is not intended for the treatment or prevention of illnesses.

\*All the testing was conducted by TOLI's in-house labs unless otherwise specified. The data shows actual test results, not guaranteed value.



# Antibacterial Performance / Antifungal Performance

of Vinyl Sheets, Tiles, Skirtings & Dadoes



Data below will help you to organize hygienic space as the guidance about performances of interior finishing materials.

Antibacterial property and mildew-proof property of floor covering play a supplementary role to prevent the growth of bacteria and mildew, and keep a more hygienic environment. Antibacterial agents can have a longer-lasting effect and be less affected by abrasion of walking or cleaning, as they are kneaded into the vinyl floor coverings rather than applied on the surface only.

## Antibacterial & Antifungal Performances

Category	Product name	Thickness (mm)	Antibacterial criteria (Antibacterial Active Value: $\geq 2.0$ )			Mildew-proof (ditto: 0 or 1)			
			Antibacterial active value			Mildew-proof value			
			Escherichia coli	Staphylococcus Aureus	MRSA				
Vinyl sheet	HITOE GRANZA/FINE	2.0	↑	↑	↑	-			
	NONWAXLEUM NW	2.0				-			
	MATURE NW	2.0				-			
	DEODORANT NS TOWARE NW	2.0				-			
	NS PLAIN NW	2.0				-			
	SF FLOOR NW	2.8				0			
	HOSPILEUM NW	2.0				0			
	CARESAFE NW	4.5				0			
	ARENA FIT	4.5				-			
	FLOORLEUM PLAIN NW/MARBLE NW	2.0/2.5				-			
	FLOORLEUM PREMIER NW SERIES *1	2.0				-			
	OPELEUM	2.0				0			
	CHEMICAL-RESISTANT SUPER K-SHEET NW	2.0				-			
	CHEMICAL-RESISTANT SUPER K-SHEET EXCELLA NW	2.0				2.0 or over	2.0 or over	2.0 or over	-
	NS AQUATREAD	2.0				0			
	NS FLATY	2.0				-			
	BATHNA ARTI	2.8				0			
	BATHNA FLORE	3.5				0			
	BATHNA REAL DESIGN	3.5				0			
	LAVANA	2.5				0			
CF SHEET-H	1.8	0							
CF SHEET-P NW	2.3	0							
CF SHEET-SD	3.5	0							
Vinyl tile	LOOSELAY MASTER NW-EX	5.0	0						
	TOUGHTEC TILE	3.0	-						
Skirting & wainscot	ANTI-SOILING & BACTERIAL WIDE SKIRTING	2.0	-						
	WAVE HABAKI (skirting)	2.0	-						
	TOLI STAIN-RESISTANT DEODORANT KOSHIKABE (dado) SHEET	1.0	0						
Other	LINOLUEM	2.5	-						

\*1 series consists of FLOOLEUM SOILUD NW, LATTICE NW, FLAKE NW, NATTY NW.

Testing Lab.: KAKEN TEST CENTER, BOKEN QUALITY EVALUATION INSTITUTE

### Antibacterial Property

[Criteria for Evaluation]

Antibacterial (if Antibacterial Active Value:  $\geq 2.0$ )

#### ● Guide for Evaluating the Data

When the antibacterial active value for each bacterium (Escherichia coli, Staphylococcus aureus, MRSA) is **more than 2.0**, the floor covering has sufficient antibacterial property.

#### ● Test Method

Antibacterial Products - Test for Antibacterial Activity and Efficacy (JIS Z 2801)

Drop 1/500 liquid bouillon of Escherichia Coli and Staphylococcus Aureus on the sterilized specimen and cover with sterilized film. Preserve them at  $35 \pm 1^\circ\text{C}$  and 90%RH for 24 hours. Afterwards wash the bacteria and count the viable bacteria by agar plate culture method. The same testing should be also conducted for non-antibacterial specimen. Based on those results, antibacterial active value can be calculated by the following formula.

Antibacterial Active Value =  $\log B/C$

B: Viable bacteria count on non-antibacterial specimen after 24 hours (pcs.)

C: Viable bacteria count on antibacterial specimen after 24 hours (pcs.)

! For vinyl sheet products, seam joints should be finished with antibacterial welding rods.

### Mildew-proof Property

[Criteria for Evaluation]

Mildew-proof = 0 or 1 (Mildew growth is invisible to the naked eye.)

Result	Visual judgment
0	Mildew growth is invisible to the naked eye and cannot be detected under a microscope as well.
1	Mildew growth is invisible to the naked eye but can be detected under a microscope.
2	Fungal filament is visible to the naked eye, and its growth part is not more than 25% of the whole specimen.
3 to 5	Fungal filament is visible to the naked eye, and its growth part is more than 25% of the whole specimen.

#### ● Test Method

Mildew-proof Testing: Test Method A (JIS Z 2911)

Spray mildew-mixed spore suspension to the specimen and grow mildew at  $29^\circ\text{C}$  and 95% RH for 4 weeks. Check the growth of fungal filament first by the naked eye, and by a stereoscopic microscope if necessary.

### Note Maintenance to keep the antimicrobial performance of vinyl flooring

To maintain the antimicrobial property of the flooring, apply a low gloss type of "T-WAX (antibacterial)" or a gloss type of anti-bacterial wax "Healthcare Coat" manufactured by C x S Corporation, as a maintenance wax. The antistatic performance of Opeleum and Chemical-resistant Super K-sheet, etc. is not significantly reduced even with the application of "Healthcare Coat."

For inquiries to C x S Corporation, please contact  
**C x S sales rep.....TEL 045-640-2280**



# Antibacterial Performance / Bacteriostatic Performance

of Carpet Tiles, Curtain Fabrics & Wall Coverings

Data below will help you to organize hygienic space as the guidance about performances of interior finishing materials.

Antibacterial & bacteriostatic properties of floor covering play a supplementary role to prevent the growth of bacteria, and keep a more hygienic environment. We have bacteriostatic carpet tiles and curtain fabrics which conforms to SEK standards, also a lot of antibacterial wall coverings which conforms to 'Performance requirement for antibacterial wall coverings' prescribed by the Wall Covering Association.

## Carpet Tiles

GA-100FH(made-to-order) and GA-8900 are equipped with bacteriostatic property as shown in the test result chart.

Bacteriostatic property Testing (GA-8900)

Mandatory Bacteria for test	Antibacterial Active Value 'A'	Multiplied Value 'F'	Criteria for bacteriostatic Product: A>F
Staphylococcus Aureus	3.7	2.7	PASS
Pneumobacillus	3.8	3.1	PASS
MRSA	4.0	2.4	PASS

\*Testing laboratory: Nissenken Quality Evaluation Center \*Prescribed washing instruction: 5 times \*Condition of Testing: F $\geq$ 1.0(viable bacteria count)

## Safety Testing

	Testing Item	Measured Value	SEK Standard
Antibacterial Agent	Acute Oral Toxicity (LD50 value)	More than 2,000mg/kg (mouse)	More than 2,000mg/kg
	Mutagenicity	Negative	Negative
	Skin Irritancy	P.I.I value=0.5	P.I.I value < 2.00
	Skin Sensitization	Negative	Negative
Product	Skin patch	No primary irritant observed	Safeness

\*Testing Lab.: Japan Food Research Laboratories, LIFE SCIENCE LABORATORIES, LTD., etc.

## Wall Coverings

Power 1000 Antibacterial Basic & Wood Deco are equipped with antibacterial property.

Antibacterial Test Viable bacteria count is observed below the requirement of 0.63.

Tested Products	Bacteria for test	Antibacterial test result		
		on inoculation	24 hours after inoculation	
Power 1000 Antibacterial Basic	Escherichia Coli	2.1 $\times$ 10 <sup>4</sup>	Antibacterial processed	<0.63
			Without processing	6.8 $\times$ 10 <sup>5</sup>
	Staphylococcus Aureus	1.9 $\times$ 10 <sup>4</sup>	Antibacterial processed	<0.63
			Without processing	5.7 $\times$ 10 <sup>4</sup>
Wood Deco	Escherichia Coli	1.2 $\times$ 10 <sup>4</sup>	Antibacterial processed	<0.63
			Without processing	6.2 $\times$ 10 <sup>5</sup>
	Staphylococcus Aureus	1.6 $\times$ 10 <sup>4</sup>	Antibacterial processed	<0.63
			Without processing	5.6 $\times$ 10 <sup>4</sup>

### ● Test Method

'Required antibacterial performance on Wallcoverings' prescribed by Wallcovering Association.

Notes on use:

- Antibacterial processed products will inhibit multiplication of Escherichia Coli and Staphylococcus Aureus, though cannot control direct infection.
- The performance will be affected if the surface is covered with dirt.

### About SEK Mark



#### Bacteriostatic-processed mark

SEK Mark is the certificate only for the products that can meet the requirements of Japan Textile Evaluation Technology Council. The certified products are designed for hospital and healthcare segments (special purpose), and they also need to pass the testing of antibacterial property to MRSA. The criteria of SEK Mark requires the strict standards of bacteriostatic property and effect control on human bodies.



Antimicrobial Finished Product



# Ease of Maintenance (Scuff-Mark Resistance) of Vinyl Sheets & Tiles

Data below will help you to compare the ease of maintenance of each flooring.

The frequency of cleaning and wax application will make a significant difference in the appearance of floorcovering. The maintenance performance of stain-resistant floorcovering is an integral element to keep a clean and comfortable environment. TOLI NW series floorings, requiring no wax maintenance, will contribute to reduction of maintenance cost.

Category	Product name	Thickness (mm)	With wax coating		Without wax coating		Overall ranking
			Paper wiping	Wet cloth wiping	Paper wiping	Wet cloth wiping	
Vinyl sheet	HITOE GRANDE	2.0	-	-	A	A	A
	HITOE FINE	2.0	-	-	A	A	A
	NONWAXLEUM NW	2.0	-	-	A	A	A
	MATURE NW *1	2.0	-	-	A	A	A
	DEODORANT NS TOWARE NW	2.0	-	-	A	A	A
	NS PLAIN NW	2.0	-	-	A	A	A
	SF FLOORNW	2.8	-	-	A	A	A
	SF FLOOR NW 3.5mm (made to order)	3.5	-	-	A	A	A
	HOSPILEUM NW	2.0	-	-	A	A	A
	FLOORLEUM PLAIN/MARBLE NW	2.0	-	-	A	A	A
	FLOORLEUM PREMIER NW series *2	2.0	-	-	A	A	A
	CARESAFE NW	4.5	-	-	A	A	A
	CF SHEET-P NW	2.3	-	-	A	A	A
	NS AQUATREAD	2.0	B	B	B	B	B
	NEW STANLOAD	2.0	C	B	B	B	B
	NS FLATY	2.0	B	B	B	D	B
OPELEUM	2.0	C	B	C	D	B	
CHEMICAL-RESISTANT SUPER K SHEET NW	2.0	-	-	A	A	A	
CHEMICAL-RESISTANT SUPER K SHEET EXCELLA NW	2.0	-	-	A	A	A	
Vinyl tile	TOUGHTEC TILE	3.0	-	-	A	A	A
	LOOSELAY MASTER NW-EX	5.0	-	-	A	A	A
	E-CLEAN NW EX	3.0	-	-	A	A	A
	LOOSELAY 40NW-EX	4.0	-	-	A	B	B
	ROYALWOOD/ROYALSTONE	3.0	B	B	D	D	B
	DINAMIC STONE	3.0	-	-	A	A	A
	PIESTA	3.0	-	-	A	A	A
	MATICO V	2.0	C	C	D	D	C
FASOL PLUS	3.0	C	C	D	D	C	
Others	LINOLEUM	2.5	B	B	C	D	B

\*1 The difference of surface embossing will affect the results. \*2 series consists of FLOORLEUM SOILUD NW, LATTICE NW, FLAKE NW, NATTY NW.

## Vinyl Sheets & Tiles

[Criteria for Evaluation] The evaluation is made by NW products **without wax** application and all other products **with wax** application.

Rank	
A	Scuff marks can be completely wiped off.
B	A fair amount of scuff marks can be wiped off.
C	Few scuff marks can be wiped off.
D	Scuff marks cannot be removed at all.

### ● Test Method

#### Stain Resistance Test (Independent test by TOLI)

Stick the test pieces in 22cm x 22cm onto 6 inner surfaces of the hexagon tumbling machine (Figure 1). Put 6 pieces of 5cm cubic rubber (Photo 1) into the machine and close the cover. Rotate the low-speed motor at 63 turns per minute for 15 minutes and reverse the rotation for 15 minutes. Then take out the test pieces and check the stains with naked eyes. After cleaning with dry paper and wet paper, check them once again with naked eyes, and evaluate.



Example of scuff marks by shoes heels, frequently seen in heavy traffic areas.

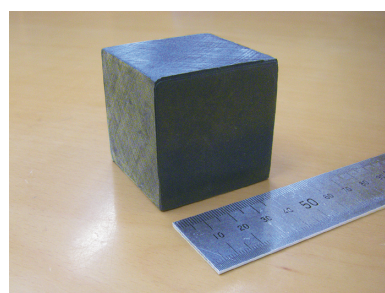
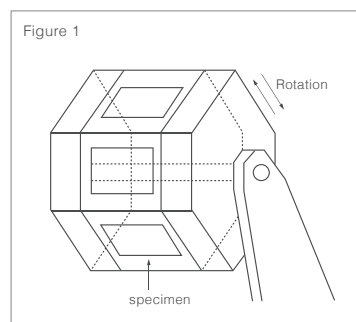

Photo 1) 5cm cubic rubber to be put into the tumbling machine

\*All the testing was conducted by TOLI's in-house labs unless otherwise specified. The data shows actual test results, not guaranteed value.



# Chemical Resistance

## of Vinyl Sheets & Tiles

**[Test Method]**

Test Method of chemical-resistant property

Put the absorbent cotton(1cmx1cm)on the floor covering and drop 1ml of chemical on it. Cover with a watch glass and leave it for 24 hours. After water washing and drying, check the appearance with naked eyes in a standing position.

**[Criteria for Evaluation]**

Specimens are observed from standing position.

Evaluate the results from 3 aspects of color, material, and gloss based on the following criteria.

- A:** No Damage B: Slightly Damaged
- C:** Damaged

Use below data as a durability performance index for specific chemicals.

Category	Product name	Code	Inorganic acid			Organic acid				Contaminator							
			1	2	3	4	5	6	7	8	9	10	11	12	13	14	
			Sulfuric acid 50%	Nitric acid 61%	Hydrochloric acid 37%	Acetic acid 99%	Oxalic acid 9%	Citric acid 20%	Lactic acid 85%	Gasoline	Lubricant	DOP	Soybean oil	Cement paste	Aniline blue	Perm solution	
Vinyl sheet	HITOE GRANZA/FINE	HTE1002	B	B	A	A	A	A	B	A	A	A	A	A	B	A	
	FLOORLEUM PLAIN NW/MARBLE NW	20FL1004	B	B	A	A	A	A	A	A	A	A	A	A	C	A	
	FLOORLEUM Premier NW series*1	20FL622	B	B	A	A	A	A	A	A	A	A	A	A	B	A	
	MATURE NW	FS4052	B	C	A	A	A	A	A	A	A	A	A	A	C	A	
	NONWAXLEUM NW	TS7013	B	B	A	A	B	A	A	A	A	A	A	B	A	A	
	HOSPILEUM NW(SF FLOOR NW/CARESAFE NW)	TS2339	B	C	B	B	A	A	A	A	A	A	A	A	C	A	
	CF SHEET-H	CF9567	A	C	A	A	A	A	A	A	A	A	B	A	A	B	A
	CF SHEET-P NW	CF3540	A	C	A	A	A	A	A	A	A	A	A	A	A	C	A
	CF SHEET-SD	CF8509	A	B	A	A	A	A	A	A	A	A	B	A	A	C	A
	TM FLOOR	TS1	A	B	C	A	A	A	B	B	A	C	A	A	B	A	A
	ANTISTATIC FLOORLEUM	TS333	A	B	B	A	A	A	B	A	A	B	A	A	A	C	A
	CHEMICAL-RESISTANT SUPER K SHEET NW	TS3540	B	C	A	A	A	A	A	A	A	A	A	A	A	A	A
	CHEMICAL-RESISTANT SUPER K SHEET EXCELLA NW	TS3720	A	C	A	A	A	A	A	A	A	A	A	A	A	A	A
	OPELEUM	TS4501	A	C	A	B	A	A	A	A	A	A	B	A	A	A	A
	EARTHLEUM	TS1001	A	B	A	A	A	A	A	A	A	A	A	A	A	C	A
	NEW STANLOAD	TS901	A	B	A	A	A	A	A	A	A	A	A	A	B	B	A
	FACTLEUM	TS8521	A	B	A	A	A	A	A	A	A	A	A	A	A	A	A
	NS SHEET NS800	NS855	A	B	A	A	A	A	A	A	A	A	A	A	A	A	A
	NS REALDESIGN NW	NS4211	A	C	A	A	A	A	A	A	A	A	A	A	B	C	B
	NS Heat-insulating GUARDENT	NS559	A	A	A	A	A	A	A	A	A	A	A	A	A	A	A
	NS PLAIN NW	NS2404	B	B	B	B	A	A	A	A	A	A	A	A	A	C	A
	NS FLATY	NS4502	A	B	B	A	A	A	A	A	A	A	A	A	A	C	A
	DEODORANT NS TOWARE NW	NS4804	A	C	A	A	A	A	A	A	A	A	A	A	A	A	A
NS AQUATRED	NS4407	A	B	A	A	A	A	A	A	A	A	A	A	B	B	A	
BATHNA FLORE/ARTI	BNF1101	B	B	A	A	A	A	A	A	A	A	A	A	A	C	A	
BATHNA REAL DESIGN	BNR3302	B	C	A	B	B	A	A	A	A	A	A	A	B	C	B	
LAVANA	LN9001	A	B	A	A	B	A	A	A	A	A	A	A	B	C	B	
Vinyl tile	MATICO V	MV78	B	B	B	B	C	C	B	A	A	B	A	A	C	A	
	CORDELLA	TC702-450	A	B	A	B	B	B	C	A	A	A	A	A	C	A	
	FASOL PLUS	FPT2072	C	B	B	B	C	C	C	A	A	B	A	A	C	A	
	VIALE	LCT603	B	C	B	C	A	A	A	A	A	A	A	A	B	A	A
	GRANOBLE	GNT7507	C	B	B	C	C	C	C	A	A	B	A	A	C	A	
	REFRIPE	RFT7007	C	B	A	C	C	C	C	A	A	B	A	A	C	A	
	STRAINE	LCT5001	C	C	A	A	A	A	A	A	A	A	A	A	C	A	
	PIESTA	LCT59	A	C	A	C	A	A	A	A	A	A	A	A	A	A	A
	MOKURIN	MOT3517	C	A	B	B	B	C	B	A	A	A	A	A	C	A	
	LINOTESTA	LCT513	B	C	B	C	A	A	A	A	A	A	A	A	B	A	A
	DYNAMIC STONE	LCT8004	B	C	A	B	A	A	A	A	A	A	A	A	A	C	A
	E-CLEAN NW-EX	ECT5013	A	C	A	B	A	A	A	A	A	A	A	A	A	A	A
	ROYALWOOD/ROYALSTONE*2	PST3107	A	B	A	A	A	A	A	A	A	A	A	A	A	A	A
	ROYALSTONE NONS	PST3181	A	B	A	A	A	A	A	A	A	A	A	A	A	A	A
	MS FRESH	MS5526	B	B	B	C	C	B	C	A	A	C	A	A	C	A	A
	MS PLAIN	MS5661	B	B	B	B	C	B	C	A	A	C	A	A	C	A	A
	LOOSELAY 50(40) NW-EX	TTN3207	A	C	A	A	A	A	A	A	A	A	A	A	A	C	A
	LOOSELAY MASTER NW-EX	TTN7002	A	C	A	A	A	A	A	A	A	A	A	A	A	A	A
	LAY FLOORING	LFT121	B	C	A	C	A	A	A	A	A	A	A	A	A	C	A
	LAY FLOORING PITAFI	LPF521	A	C	A	A	A	A	A	A	A	A	A	A	A	C	A
	FREE TILE	TT45413	C	B	A	A	C	C	B	A	A	B	A	A	C	A	A
	FREE TILE S	TT4545526	C	C	B	B	C	C	C	A	A	B	A	A	C	A	A
	NS TILE	TT12	A	C	A	C	A	A	A	A	A	A	A	A	B	A	A
	PLART	PP1108-500	B	C	A	A	B	A	A	B	B	B	B	B	A	C	A
	TOUGHTEC TILE	LHT1011	B	C	B	B	B	A	A	A	A	A	A	A	B	A	A

\*1: series consists of FLOOLEUM SOILUD NW, LATTICE NW, FLAKE NW, NATTY NW. \*2: except for ROYALSTONE NONS.



# Chemical Resistance



## of Vinyl Sheets & Tiles

Use below data as a durability performance index for specific chemicals.

### [Test Method]

Test Method of chemical-resistant property

Put the absorbent cotton (1cmx1cm) on the floor covering and drop 1ml of chemical on it. Cover with a watch glass and leave it for 24 hours. After water washing and drying, check the appearance with naked eyes in a standing position.

### [Criteria for Evaluation]

Specimens are observed from standing position.

Evaluate the results from 3 aspects of color, material, and gloss based on the following criteria.

A: No Damage B: Slightly Damaged  
C: Damaged

Category	Product name	Code	Alkali		Sterilizer & Reagent													Saline
			15	16	17	18	19	20	21	22	23	24	25	26	27	28		
			Sodium hydroxide 25%	Ammonia water 28%	Phenol 8%	Formalin 37%	Lodoform	Wright blood stain	Povidone Iodine 10%	Cresol 100%	Giemsa blood stain	Papanicolaou Stain Solution	Hydrogen Peroxide Solution 31%	Hematoxylin Mordant	Hibitane Tincture	Potassium permanganate		
Vinyl sheet	HITOE GRANZA/FINE	HTE1002	B	A	B	A	C	C	C	B	C	B	A	A	A	A	C	
	FLOORLEUM PLAIN NW	20FL1004	B	A	B	A	C	C	C	B	C	B	A	A	A	A	C	
	FLOORLEUM Premier NW series *1	20FL622	B	A	A	A	C	C	C	B	C	B	A	A	A	A	C	
	MATURE NW	FS4052	C	A	A	A	C	C	C	B	C	A	A	A	A	A	C	
	NONWAXLEUM NW	TS7013	B	A	B	A	C	C	C	B	C	A	A	A	A	A	C	
	HOSPILEUM NW (SF FLOOR NW/CARESAFE NW)	TS2339	B	A	A	A	C	C	C	B	C	C	A	B	A	A	C	
	CF SHEET-H	CF9567	A	A	A	A	C	C	B	A	C	A	A	A	A	A	C	
	CF SHEET-P NW	CF3540	A	A	B	A	C	C	C	C	C	C	A	B	A	A	C	
	CF SHEET-SD	CF8509	A	A	A	A	C	C	B	A	C	A	A	B	A	A	C	
	TM FLOOR	TS1	A	A	A	A	B	C	B	B	B	A	B	A	B	B	B	
	ANTISTATIC FLOORLEUM	TS333	A	A	A	A	C	C	C	B	C	B	A	A	A	A	C	
	CHEMICAL-RESISTANT SUPER K SHEET NW	TS3540	B	A	A	A	C	C	C	A	C	A	A	A	A	A	C	
	CHEMICAL-RESISTANT SUPER K SHEET EXCELLA NW	TS3720	A	A	A	A	C	C	B	A	C	A	A	A	A	A	C	
	OPELEUM	TS4501	A	A	B	A	C	C	A	B	C	B	A	A	A	A	C	
	EARTHLEUM	TS1001	B	A	A	A	C	C	C	A	C	C	A	C	A	A	C	
	NEW STANLOAD	TS901	B	A	B	A	C	C	C	B	C	B	A	A	A	A	C	
	FACTLEUM	TS8521	A	A	A	A	C	C	A	A	C	A	A	A	A	A	B	
	NS SHEET NS800	NS855	A	A	A	A	C	C	B	A	C	A	A	A	A	A	C	
	NS REALDESIGN NW	NS4211	B	A	B	A	C	C	C	C	C	B	A	A	A	A	C	
	NS Heat-insulating GUARDENT	NS559	A	A	A	A	C	C	B	A	B	A	A	A	A	A	C	
	NS PLAIN NW	NS2404	B	A	A	A	C	C	C	A	C	B	A	A	A	A	C	
	NS FLATY	NS4502	B	A	A	A	C	C	C	B	C	B	A	A	A	A	C	
	DEODORANT NS TOWARE NW	NS4804	B	A	B	A	C	C	B	C	C	A	A	A	A	A	C	
NS AQUATRED	NS4407	B	A	A	A	C	C	C	B	C	B	A	A	A	A	C		
BATHNA FLORE/ARTI	BNF1101	A	A	A	A	C	C	C	A	C	C	A	B	A	A	C		
BATHNA REAL DESIGN	BNR3302	B	B	B	A	C	C	C	C	C	C	A	B	A	A	C		
LAVANA	LN9001	B	B	A	A	C	C	C	B	C	C	A	B	A	A	C		
Vinyl tile	MATICO V	MV78	A	A	A	A	C	C	B	B	C	B	A	A	A	A	C	
	CORDELLA	TC702-450	B	B	B	A	C	C	B	B	C	B	A	A	A	A	C	
	FASOL PLUS	FPT2072	B	A	B	A	C	C	B	B	C	C	A	A	A	A	C	
	VIALE	LCT603	B	A	B	A	C	C	C	B	C	C	A	A	A	A	C	
	GRANOBLE	GNT7507	B	A	B	A	C	C	B	B	C	C	A	A	A	A	C	
	REFRIPE	RFT7007	A	A	B	A	C	C	B	B	C	C	A	A	A	A	C	
	STRAINE	LCT5001	B	A	A	A	C	C	C	B	C	C	A	A	A	A	C	
	PIESTA	LCT59	C	A	B	A	C	C	C	C	C	C	A	A	A	A	C	
	MOKURIN	MOT3517	A	A	A	A	B	C	A	A	C	A	A	A	A	A	C	
	LINOTESTA	LCT513	B	A	B	A	C	C	C	B	C	C	A	A	A	A	C	
	DYNAMIC STONE	LCT8004	B	A	A	A	C	C	C	A	C	B	A	A	A	A	C	
	E-CLEAN NW-EX	ECT5013	A	A	B	A	C	C	B	B	C	A	A	A	A	A	C	
	ROYALWOOD/ROYALSTONE *2	PST3107	A	A	A	A	C	C	B	A	C	A	A	A	A	A	B	
	ROYALSTONE NONS	PST3181	A	A	B	A	C	C	C	B	C	A	A	A	A	A	C	
	MS FRESH	MS5526	A	A	A	A	C	C	B	A	C	C	A	B	A	A	C	
	MS PLAIN	MS5661	A	A	A	A	C	C	B	A	C	C	A	B	A	A	C	
	LOOSELAY 50(40) NW-EX	TTN3207	B	A	B	A	C	C	C	B	C	B	A	A	A	A	C	
	LOOSELAY MASTER NW-EX	TTN7002	A	A	A	A	C	C	A	A	C	A	A	A	A	A	C	
	LAY FLOORING	LFT121	B	A	C	A	C	C	C	C	C	B	A	A	A	A	C	
	LAY FLOORING PITAFI	LPF521	B	A	A	A	C	C	C	C	C	C	A	A	A	A	C	
	FREE TILE	TT45413	A	A	A	A	C	C	B	A	C	B	A	A	B	B	C	
	FREE TILE S	TT4545526	B	A	A	A	B	C	C	A	C	C	B	B	B	B	C	
	NS TILE	TT12	C	A	A	A	C	C	B	C	C	C	A	A	A	A	C	
PLART	PP1108-500	B	A	A	A	C	B	A	B	C	B	A	B	A	A	C		
TOUGHTEC TILE	LHT1011	B	A	C	A	C	B	B	B	B	A	A	A	A	A	C		

\*1: series consists of FLOORLEUM SOILUD NW, LATTICE NW, FLAKE NW, NATTY NW \*2: except for ROYALSTONE NONS.





# Chemical Resistance

## of Vinyl Sheets & Tiles

Use below data as a durability performance index for specific chemicals.

[Test Method]

Test Method of chemical-resistant property

In the room where chemicals are handled, the floor used to be finished with coatings or ceramic tiles. Now, they are being replaced by the vinyl floor coverings with sufficient durability and safety. Chemical resistance of the floor covering can be checked with naked eyes. The less appearance changes, the better chemical resistance it has.

[Criteria for Evaluation]

Specimens are observed from standing position.

Evaluate the results from 3 aspects of color, material, and gloss based on the following criteria.

- A: No Damage B: Slightly Damaged
- C: Damaged

Category	Product name	Code	Organic solvent						Disinfectant & Detergent								
			29	30	31	32	33	34	35	36	37	38	39	40	41	42	
			Methanol	MEK	Ethyl acetate	Tetrahydrofuran	Xylene	Toluene	WELPAS	Ethanol for disinfection 80%	Neutral detergent	Oxygenic bleach	Sodium hypochlorite 5%	Bleaching powder	TEGO51 diluted to 1.5%	Hypochlorite water (200 ppm)	
Vinyl sheet	HITOE GRANZA/FINE	HTE1002	A	A	A	C	A	A	A	A	A	A	A	A	A	A	
	FLOORLEUM PLAIN NW	20FL1004	A	B	A	C	A	A	A	A	A	A	A	A	A	A	
	FLOORLEUM Premier NW series *1	20FL622	A	C	C	C	C	C	A	A	A	A	A	A	A	A	
	MATURE NW	FS4052	A	C	A	C	C	C	A	A	A	A	A	A	A	A	
	NONWAXLEUM NW	TS7013	A	C	A	C	A	A	A	A	A	A	A	A	A	A	
	HOSPILEUM NW (SF FLOOR NW/CARESAFE NW)	TS2339	A	C	A	C	A	B	A	A	A	A	A	A	A	A	
	CF SHEET-H	CF9567	A	C	C	C	C	C	A	A	A	A	A	A	A	A	
	CF SHEET-P NW	CF3540	A	C	C	C	B	B	A	A	A	A	A	A	A	A	
	CF SHEET-SD	CF8509	A	C	C	C	B	B	A	A	A	A	A	A	A	A	
	TM FLOOR	TS1	B	B	C	C	B	C	A	A	A	A	A	A	A	A	
	ANTISTATIC FLOORLEUM	TS333	A	B	B	C	B	C	A	A	A	A	A	A	A	A	
	CHEMICAL-RESISTANT SUPER K SHEET NW	TS3540	A	B	A	C	A	A	A	A	A	A	A	A	A	A	
	CHEMICAL-RESISTANT SUPER K SHEET EXCELLA NW	TS3720	A	C	A	C	A	A	A	A	A	A	A	A	A	A	
	OPELEUM	TS4501	A	C	B	C	A	B	A	A	A	A	A	A	A	A	
	EARTHLEUM	TS1001	A	C	C	C	A	A	A	A	A	A	A	A	A	A	
	NEW STANLOAD	TS901	A	C	B	C	A	B	A	A	A	A	A	A	A	A	
	FACTLEUM	TS8521	A	A	A	C	A	A	A	A	A	A	A	A	A	A	
	NS SHEET NS800	NS855	A	A	A	C	A	A	A	A	A	A	A	A	A	A	
	NS REALDESIGN NW	NS4211	A	C	A	C	A	B	A	A	A	A	A	A	B	A	
	NS Heat-insulating GUARDENT	NS559	A	A	A	C	A	A	A	A	A	A	A	A	A	A	
	NS PLAIN NW	NS2404	A	B	A	C	A	A	A	A	A	A	A	A	A	A	
	NS FLATY	NS4502	A	C	B	C	A	A	A	A	A	A	A	A	A	A	
	DEODORANT NS TOWARE NW	NS4804	A	C	C	C	C	C	A	A	A	A	A	A	A	A	
NS AQUATREAD	NS4407	A	C	C	C	A	A	A	A	A	A	A	A	A	A		
BATHNA FLORE/ARTI	BNF1101	A	A	A	B	A	A	A	A	A	A	A	A	A	A		
BATHNA REAL DESIGN	BNR3302	A	C	C	C	C	C	A	A	A	A	A	B	B	A		
LAVANA	LN9001	A	C	C	C	A	A	A	A	A	A	A	B	A	A		
Vinyl tile	MATICO V	MV78	B	B	B	C	A	A	A	A	A	B	A	A	A		
	CORDELLA	TC702-450	B	C	B	C	B	B	A	A	A	A	A	A	A		
	FASOL PLUS	FPT2072	B	C	B	C	A	A	A	A	A	A	A	A	B		
	VIALE	LCT603	B	C	C	C	C	C	A	A	A	A	A	A	A		
	GRANOBLE	GNT7507	B	C	B	C	B	A	A	A	A	A	A	A	A		
	REFRIPE	RFT7007	B	B	B	C	A	A	A	A	A	A	A	A	B		
	STRAINE	LCT5001	B	C	B	C	A	A	A	A	A	A	A	A	A		
	PIESTA	LCT59	C	C	C	C	B	A	A	A	A	A	A	A	A		
	MOKURIN	MOT3517	A	B	A	C	A	A	A	A	A	B	A	A	A		
	LINOTESTA	LCT513	C	C	C	C	C	C	A	A	A	A	A	A	A		
	DYNAMIC STONE	LCT8004	A	C	C	C	A	B	A	A	A	A	A	A	A		
	E-CLEAN NW-EX	ECT5013	A	C	B	C	A	A	A	A	A	A	A	A	A		
	ROYALWOOD/ROYALSTONE *2	PST3107	A	C	A	C	A	A	A	A	A	A	A	A	A		
	ROYALSTONE NONS	PST3181	A	C	C	C	C	C	A	A	A	A	A	A	A		
	MS FRESH	MS5526	B	C	B	C	B	C	A	B	A	A	A	A	A		
	MS PLAIN	MS5661	B	C	B	C	B	C	A	B	A	A	A	A	A		
	LOOSELAY 50(40) NW-EX	TTN3207	A	C	C	C	B	B	A	A	A	A	A	A	A		
	LOOSELAY MASTER NW-EX	TTN7002	A	B	B	C	A	A	A	A	A	A	A	A	A		
	LAY FLOORING	LFT121	A	C	C	C	C	C	A	A	A	A	A	A	A		
	LAY FLOORING PITAFI	LPF521	A	C	C	C	C	C	A	A	A	A	A	A	A		
	FREE TILE	TT45413	B	B	B	C	A	A	A	A	A	B	A	A	A		
	FREE TILE S	TT4545526	A	C	B	C	A	B	A	A	A	C	A	A	A		
	NS TILE	TT12	A	B	A	B	A	C	A	A	A	A	A	A	A		
	PLART	PP1108-500	A	A	A	B	B	B	A	A	A	A	A	A	A		
	TOUGHTEC TILE	LHT1011	A	A	A	A	A	A	A	B	A	A	B	B	B		

\*1: series consists of FLOOLEUM SOILUD NW, LATTICE NW, FLAKE NW, NATTY NW. \*2: except for ROYALSTONE NONS.



# Slip Resistance



of Vinyl Sheets, Tiles & Carpet Tiles



Use below data as a performance index for creating space that takes into consideration the fall prevention.

Accident (slip and fall) is more likely to occur on wet or dusty floor where it is more slippery than normal dry and clean condition. It may also occur when wearing slippery footwear. For the prevention of fall accidents, it's recommended to select the flooring of appropriate slip resistance according to the place and its use.

## Slip Resistance of Floorings (C.S.R. value)

Category	Product name	Water + Dust (smaller)	← The bigger, the less slippery → (bigger)		Dry surface	A rank: slip-resistant
			← The bigger, the less slippery → (bigger)			Evaluated rank
Vinyl sheet	TOLI NS STEP 800	0.64			0.73	A
	NS REAL DESIGN NW (4300series)	0.54			0.82	A
	NS AQUATREAD	0.55			0.81	A
	BATHNA FLORE	0.53			0.86	A
	NS PLAIN NW	0.52			0.83	A
	NS SHEET NS800	0.51			0.75	A
	NS REALDESIGN NW (4200series)	0.51			0.78	A
	BATHNA REALDESIGN	0.51			0.81	A
	BATHNA ARTI	0.51			0.82	A
	NS FLATY	0.50			0.71	A
	LAVANA	0.50			0.85	A
	DEODORAMT NS TOWARE NW	0.48			0.74	A
	CHEMICAL-RESISTANT SUPER K SHEET EXCELLA NW	0.49			0.75	B
	CHEMICAL-RESISTANT SUPER K SHEET NW	0.52			0.82	B
	CARESAFE NW	0.47			0.71	B
	SF FLOOR NW (TOH: in emboss length direction)	0.47			0.73	B
	HOSPILEUM NW (TOH: in emboss length direction)	0.47			0.73	B
	HOSPILEUM NW	0.47			0.76	B
	OPELEUM	0.45			1.02	B
	FLOORLEUM PLAIN/ MARBLE NW	0.44			0.69	B
	SF FLOOR 3.5mm (made to order)	0.44			0.75	B
	SF FLOOR NW	0.44			0.76	B
	SF FLOOR NW (TOH: in cross-emboss direction)	0.43			0.68	B
	HOSPILEUM NW (TOH: in cross-emboss direction)	0.43			0.68	B
	NONWAXLEUM NW (TS7000's)	0.43			0.79	B
	NEW STANLOAD	0.43			0.73	B
	MATURE NW	0.42			0.67	B
	FLOORLEUM PREMIER NW series*1	0.42			0.69	B
	NONWAXLEUM NW (TS5000's)	0.42			0.74	B
	HITOE FINE	0.41			0.66	B
HITOE GRANZA	0.40			0.62	B	
Vinyl tile	ROYALSTONE NONS	0.46			0.66	A
	PIESTA	0.47			0.78	B
	TOUGHTTEC TILE	0.48			0.70	B
	LOOSELAY MASTER NW-EX	0.46			0.78	B
	E-CLEAN NW-EX	0.43			0.84	B
	ROYAL WOOD	0.43			0.77	B
	MATICO V	0.43			0.70	B
	LOOSELAY 40 NW-EX	0.40			0.73	B
	FASOL PLUS	0.40			0.74	B
	LOOSELAY 50 NW-EX	0.40			0.69	B
Carpet tile	DC-1100	0.61			0.74	A
	GA-100 + Underlay Sheet for Carpet Tiles	0.59			0.80	A
	GA-100	0.56			0.83	A
	GA-8900 + Underlay Sheet for Carpet Tiles	0.54			0.63	A
	GA-8900	0.53			0.63	A
Other ordinary products	Coated floor (flat-surface type)	0.44			1.06	B
	Cork tile	0.44			0.65	B
	Linoleum	0.43			0.69	B
	Wood flooring	0.38			0.80	C
Ceramic tile (gloss-surfaced)	0.30			0.96	C	

\*1: series consists of FLOOLEUM SOILUD NW, LATTICE NW, FLAKE NW, NATTY NW.

The specimens of these data are of unused floor coverings. Though some products are not under the NS ranges, they also have good result. But they cannot keep their performance, depending on how they are used which affect the changes of the surface. They may lose slip-resistant performance due to surface change in certain situation. When slip resistance is required, slip resistant products (NS sheet) are highly recommended.

\*Please refer to separate data for C.S.R.·B. value if you need slip resistance value by barefoot.

Print direction:  
SF Floor NW / HOSPILEUM NW

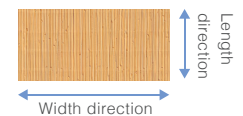

### ● Guide for Evaluating the Data

Judged in condition of both 'Dry' and 'Wet + Dusty'. The bigger the number of CSR value (the index of slip resistance) is, the less slippery the floor is. If the number of 'Dry' and 'Wet + Dusty' is close to each other, such floor can also contribute to slip resistance.

[Criteria for Evaluation] "A" rank is evaluated as slip-resistant floor in TOLI

Rank	Test Result (C.S.R. Value)	Guide for uses
A	≧ 0.45 / Wet + Dusty	Kitchens, restrooms, etc., which floor often has water on surface.
B	≧ 0.40 / Wet + Dusty	The ordinary walkway, which floor seldom has water on surface.
C	< 0.40 / Dry or Wet + Dusty	Not recommended for the area where slip-resistance is required.



# Slip Resistance



of Vinyl Sheets, Tiles & Carpet Tiles



## ● Test Method

**C.S.R. value** is measured according to JIS A1454 (Slip Test)

Maximum C.S.R. value (Coefficient of Slip Resistance) of testing flooring is measured by rubber board of 56cm<sup>2</sup> bottom area and vertically loaded with 785N, by pulling it 18 degrees upward with 785N/sec tensile strength.

- 1. Constant speed motor
- 2. Decelerator
- 3. Wire
- 4. Tensile speed regulator
- 5. Rubber board
- 6. Test piece



## Slip resistance test by barefoot (C.S.R.·B. value)

C.S.R.·B. value of 0.7 or over is reassuring floor level.

Category	Product name	Thickness (mm)	0.3% soapy water	Slippery ← 1 ————— * 2 * 3 * 4 * 5 → water					Slip-resistant	Evaluation	
				0.5	0.6	0.7	0.8	0.9			1.0
Vinyl sheet	BATHNA FLORE	3.5	0.96							1.22	○
	BATHNA REAL DESIGN (BNR3200-3400)	3.5	0.86							1.17	○
	BATHNA ARTI	2.8	0.84							1.11	○
	NS SHEET NS550 GUARDENT	2.5	0.99							1.03	○
	BATHNA REAL DESIGN (BNR3100)	3.5	0.71							0.93	○
	Ordinary vinyl sheet	2.0	0.63							0.74	-
Ordinary others	Ceramic tiles	-	1.19							1.19	○
	FRP floor of modular bath	-	0.85							1.02	○

[Criteria for Evaluation] ○ represents reassuring floor with the C.S.R.·B. value of **0.7 or more** on 0.3% soapy water.

## ● Guide for Evaluating the Data

According to the test result in actual bathroom, it can be ranked as safety floor when the C.S.R.·B. value is **0.7 or more**.

## ● Test Method

**C.S.R.·B value** Assumed test of barefoot slip resistance

Pull an uneven rubber piece (refer to photo) with 56 cm<sup>2</sup> bottom area and the vertical load of 785N, 18 degrees upward with 785N/sec tensile strength. C.S.R.·B. value is calculated by the total of P-max and P-min (refer to Figure 1) divided by vertical load (785N). The bigger C.S.R.·B. value represents the better slip resistance.

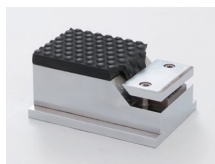

$$C.S.R.·B. Value = \frac{P-max(N) + P-min(N)}{\text{vertical load (785N)}}$$

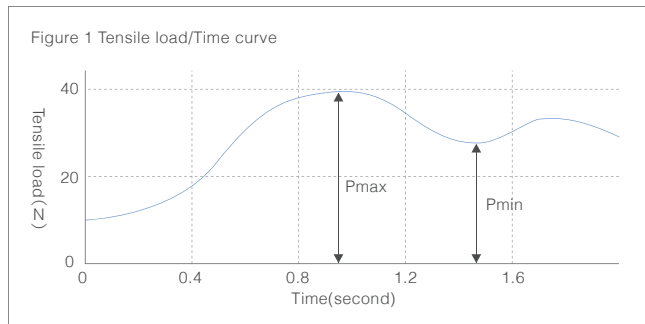

\*All the testing was conducted by TOLI's in-house labs unless otherwise specified. The data shows actual test results, not guaranteed value.



# Impact-Absorbent Property



of Vinyl Sheets, Tiles & Carpet Tiles



Use below data as a performance index to prevent injuries due to fall.

Shock absorption of the flooring is evaluated by the impact value of the dropping item onto the flooring. This impact value can be a barometer for reducing the risk of injury in case of falls. Elastic floor with cushioning effect is generally supposed to be superior in impact-absorption.

The smaller G value is, the better impact absorption floor has.

Category	Product name	Thickness (mm)	Shorter bar represents better impact absorption.(G value)		G value	m/s <sup>2</sup>	Evaluation	
			High absorption ←	→ Low absorption				
Vinyl sheet	SF FLOOR NW + Underlay sheet	7.3			84	823	S	
	HOSPILEUM NW + Underlay sheet	6.5			85	833	S	
	CARESAFE NW	4.5			94	921	S	
	CF SHEET-SD	3.5			94	921	S	
	ARENA FIT	4.5			96	941	S	
	BATHNA REAL DESIGN	3.5			104	1019	A	
	CF SHEET-P NW	2.3			108	1058	A	
	BATHNA FLORE	3.5			110	1078	A	
	NS REAL DESIGN NW	2.5			111	1088	A	
	SF FLOOR 3.5mm (made to order)	3.5			115	1127	A	
	CF SHEET-H	1.8			117	1147	B	
	SF FLOOR NW	2.8			118	1156	B	
	HOSPILEUM NW	2.0			125	1225	B	
	BATHNA ARTI	2.8			129	1264	B	
	Vinyl tile	NS FLATY	2.0			130	1274	C
		OPELEUM	2.0			144	1411	C
FLOORLEUM PLAIN/MARBLE NW		2.0			145	1421	C	
LOOSELAY 50 NW-EX		5.0			143	1401	C	
Carpet tile	ROYAL WOOD/ ROYAL STONE	3.0			144	1411	C	
	MATICO V	2.0			146	1431	C	
	TOUGHTEC TILE	3.0			149	1460	C	
	GA-100 + Underlay sheet for carpet tile	10.5			97	951	S	
	GA-8900 + Underlay sheet	10.0			99	970	S	
	DC-1100	10.0			111	1088	A	
Others	CORENTE V (GX-9300 V)	6.5			124	1215	B	
	GA-100	6.5			124	1215	B	
	GA-8900	6.0			128	1254	B	
	Tatami	55.0			55	539	S	
	Cork tile	5.0			116	1137	B	
	Linoleum	2.5			142	1392	C	
Wooden flooring	12.0			143	1401	C		
Coated floor (flat-surface type)	-			150	1470	C		
Concrete *1	-			150	1470	C		

[Criteria for Evaluation]

Rank	G value	m/s <sup>2</sup>	Guide for uses
S	100 G or less	980	Used as a safety floor, expected to protect from injury by falls.
A	Over 100 G- 115 G	980~1127	Used at area with high possibility of falls.
B	Over 115 G- 130 G	1127~1274	Used as an ordinary flooring where safety is expected in case of falls.
C	Ordinary floor (over130G)		Used as an ordinary flooring.

● Test Method

Drop the weight as heavy as assumed human head (3.85kg) from 20±1 cm height onto the floor specimen. The accelerometer attached on the weight shows G values of each floor specimen, which represents impact absorption of each flooring.

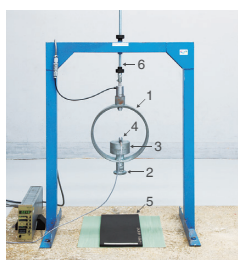

Measuring system of head model's impact onto floorings

Ref.	Description
1	Steel frame (216.3mm dia., 8.2mm thick, 40mm wide)
2	Steel head (50mm curvature radius, 50mm diameter)
3	Weight (1.34kg)
4	Accelerometer
5	Rubber plate (8mm thick, Shore A hardness scale-37), 300mm×150mm dimensions)
6	Hanging wire

● Guide for Evaluating the Data

Impact absorption is reflected in G value. The bigger the G value is, the more the impact damage is caused. Impact absorption is mainly affected by subfloor materials rather than floor coverings. If concrete subfloor is compared with timber-structured subfloor, the latter is much superior in shock absorption. Subfloor makes much bigger difference in shock absorption than the material difference of floor coverings. Impact absorption can highly be improved by the use of underlayment even on the same subfloor.

● Comparison of Shock Absorption between Concrete and Wood \*1

	Subfloor structure	Dropped point	G value
	Concrete Slab		150
	Concrete Slab + Sleeper + 12mm Plywood	1. Center between sleepers	44
		2. Just above sleeper	117
	Concrete Slab + Sleeper + joist + 12mm Plywood	3. Center between joists	44
		4. Just above joists	66
5. Just above joist on sleeper		102	

↳ Note Underlayment

We have Underlay Sheet for ordinary vinyl sheet and SF Floor NW, which will improve the impact absorption of the floorings. Underlay sheet for Carpet tile is also available.

\*All the testing was conducted by TOLI's in-house labs unless otherwise specified. The data shows actual test results, not guaranteed value.



# Antistatic property



of Vinyl Sheets, Tiles &amp; Carpet Tiles

**Use below data as a performance index to prevent malfunctioning of electronic equipment from human's static.**

As indoor air is controlled better now, flooring materials ranked C or better are mostly sufficient as the flooring at hospitals, welfare facilities for old people and residence as well. In order to prevent malfunctioning of inspection devices, 'rank' and 'guide for uses' shall be referred to for floor selection.

The flooring with less resistivity has better property to discharge electricity.

Category	Product name	Thickness (mm)	Surface resistivity ( $\Omega$ )	Volume resistivity ( $\Omega$ )	Static Charge to person (kV)	Evaluation
Vinyl sheet	<b>EARTHLEUM</b>	2.0	<b><math>9.0 \times 10^4</math></b>	<b><math>6.2 \times 10^4</math></b>	0.1	<b>A</b>
	ANTISTATIC FLOORLEUM	2.0	<b><math>3.4 \times 10^8</math></b>	<b><math>2.7 \times 10^7</math></b>	0.5	<b>B</b>
	CHEMICAL-RESISTANT SUPER K SHEET NW	2.0	<b><math>2.6 \times 10^9</math></b>	<b><math>3.8 \times 10^8</math></b>	0.3	<b>B</b>
	OPELEUM	2.0	<b><math>2.0 \times 10^{10}</math></b>	<b><math>2.8 \times 10^8</math></b>	0.6	<b>B</b>
	CHEMICAL-RESISTANT SUPER K SHEET EXCELLA NW	2.0	<b><math>6.5 \times 10^9</math></b>	<b><math>2.6 \times 10^9</math></b>	0.5	<b>B</b>
	NEW STANLOAD	2.0	<b><math>4.4 \times 10^{10}</math></b>	<b><math>3.5 \times 10^9</math></b>	0.4	<b>B</b>
	CARESAFE NW	4.5	<b><math>6.2 \times 10^{10}</math></b>	<b><math>1.2 \times 10^9</math></b>	1.3	C
	HITOE GRANZA/FINE	2.0	<b><math>1.0 \times 10^{10}</math> or more</b>	<b><math>1.0 \times 10^{10}</math> or more</b>	>3.0	C
	NONWAXLEUM NW	2.0			>3.0	C
	MATURE NW	2.0			>3.0	C
	DEODORANT NS TOWARE NW	2.0			>3.0	C
	SF FLOOR NW	2.8			>3.0	C
	SF FLOOR NW + Underlay Sheet	7.3			>3.0	C
	SF FLOOR NW 3.5mm	3.5			>3.0	C
	HOSPILEUM NW	2.0			>3.0	C
	HOSPILEUM NW + Underlay Sheet	6.5			>3.0	C
	FLOORLEUM Plain NW/ Mable NW	2.0			>3.0	C
	FLOORLEUM PREMIER NW series *1	2.0	>3.0	C		
	NS AQUATREAD	2.0	>3.0	C		
	NS FLATY	2.0	>3.0	C		
Vinyl tile	LOOSELAY 40 NW-EX	4.0	<b><math>5.6 \times 10^9</math></b>	<b><math>2.3 \times 10^9</math></b>	0.2	<b>B</b>
	LOOSELAY MASTER NW-EX	5.0	<b><math>4.9 \times 10^9</math></b>	<b><math>3.8 \times 10^9</math></b>	0.6	<b>B</b>
	LOOSELAY 50 NW-EX	5.0	<b><math>4.8 \times 10^9</math></b>	<b><math>3.1 \times 10^9</math></b>	0.3	<b>B</b>
	E-CLEAN NW-EX	3.0	<b><math>1.2 \times 10^{10}</math></b>	<b><math>3.8 \times 10^9</math></b>	>3.0	C
	ROYAL WOOD / ROYAL STONE	3.0	<b><math>1.0 \times 10^{10}</math> or more</b>	<b><math>1.0 \times 10^{10}</math> or more</b>	>3.0	C
	TOUGHTEC TILE	3.0			>3.0	C
	STRAINE	3.0			>3.0	C
	MATICO V	2.0			>3.0	C
	FASOL PLUS	3.0			>3.0	C
Carpet tile	<b>GA-100 SA (Super Antistatic)</b>	6.5	<b><math>6.4 \times 10^8</math></b>	<b><math>2.0 \times 10^7</math></b>	<b>0.4</b>	<b>a</b>
	<b>DC-1100 (DUST-CONTROL)</b>	10.0	<b><math>7.0 \times 10^{10}</math></b>	<b><math>2.3 \times 10^{10}</math></b>	<b>0.4</b>	<b>a</b>
	<b>GA-8900</b>	6.0	<b><math>1.1 \times 10^{12}</math></b>	<b><math>5.0 \times 10^{10}</math></b>	<b>0.5</b>	<b>a</b>
	<b>GA-100</b>	6.5	<b><math>5.9 \times 10^{11}</math></b>	<b><math>1.9 \times 10^{11}</math></b>	<b>0.6</b>	<b>a</b>
	<b>CORENTE-V GX-9300 V</b>	6.5	<b><math>2.4 \times 10^{11}</math></b>	<b><math>1.2 \times 10^{11}</math></b>	<b>0.7</b>	<b>a</b>
Others	Linoleum	2.5	<b><math>1.0 \times 10^{10}</math> or more</b>	<b><math>1.0 \times 10^{10}</math> or more</b>	>3.0	C

\*1: series consists of FLOOLEUM SOILUD NW, LATTICE NW, FLAKE NW, NATTY NW.

\*All the testing was conducted by TOLI's in-house labs unless otherwise specified. The data shows actual test results, not guaranteed value.



# Antistatic property



## of Vinyl Sheets, Tiles & Carpet Tiles



### Vinyl Sheets & Tiles

[Criteria for Evaluation]

Rank	Volume resistance value	Guide for uses
A	$1 \times 10^4 \sim 1 \times 10^7 \Omega$	Conductive grade: computer control rooms, etc.
B	$1 \times 10^7 \sim 1 \times 10^{10} \Omega$	Antistatic grade: for automated offices, operating rm., inspection rm., pharm. rm., etc.
C	$1 \times 10^{10} \Omega$ or more	General grade: where generation of static electricity is not a concern

#### ● Test Method

Antistatic property test (at 23°C, 25%RH)

##### 1. Surface resistance test (Independent test by TOLI)

With the use of the Super-Insulation Resistance Tester, check the direct current through flooring between two electrodes. **The less resistance means** the less charge of static electricity.

##### 2. Volume resistance test (according to JIS A 1454)

With the use of the same tester as "1", check the electric resistance between two electrodes. One is placed on flooring, the other is connected to the metal plate. **The smaller the resistance is**, the less static electricity is generated.

! Vinyl floorings are designed with the emphasis on antistatic property, not on static charge to human bodies. Antistatic property of carpet tile is tested in accordance with JIS L 4406.

#### ● Guide for Evaluating the Data

Antistatic property of vinyl floor covering is evaluated by volume resistance value. **The less the resistance is**, the quicker the static electricity is discharged. And the more humid a room is, the more quickly the electricity is discharged.

##### 1. Surface resistance test

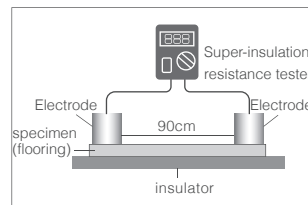

##### 2. Volume resistance test

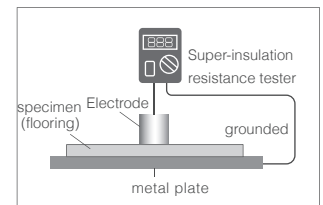

### Carpet Tiles

[Criteria for Evaluation]

Rank	Static charge	Guide for uses
a	$\leq 1.0 \text{ kV}$	The rooms with OA equipment, or antistatic area
b	$\leq 3.0 \text{ kV}$	General area requiring little antistatic property
c	$> 3.0 \text{ kV}$	Places with low possibility to generate static

#### ● Test Method

Assessment of static electricity charge—Walking test (in accordance to JIS L 1021-16)

This test is to measure static charge to human by stepping on floor specimen. **The less charge represents** the better antistatic property (at 23°C, 25% R.H./ Shoes of synthetic rubber sole.).

#### ● Guide for Evaluating the Data

Test method to measure the static charge of a human walking.

This Japanese original test method is widely adopted in Japanese carpet industry according to JIS, and the static charge below 3 kV is usually recognized as safe level. **Note; Although vinyl floorings are installed with adhesive at job sites, a test piece in this method is loose-laid on insulation material. Thus, static charge to a human walking in actual case may show lower value than this test result.**

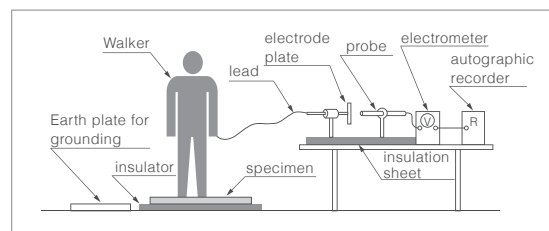



# Durability against rolling loads



Use below data as a performance index to judge the durability against rolling loads.

Equipment such as stretchers, carts, pallet trucks, wheeled chairs, etc. give stress on floorings not only by their own weight but also by caster rolling. The cause of delamination and/or damage of floor coverings where casters run back and forth, is the stress by rolling loads affecting significantly the floorings' durability.

S & A rank represents enough durability against rolling loads.

Category	Product name	Thickness (mm)	Adhesive	Evaluation
Vinyl sheet	NONWAXLEUM NW	2.0	EPOGREY S	S
	OPELEUM	2.0	EPOGREY S	S
	New STANLOAD	2.0	EPOGREY S	S
	HITOE GRANZA/FINE	2.0	EPOGREY SS	A
	Deodorant NS TOWARE NW	2.0	EPOGREY S	A
	SF Floor NW	2.8	US CEMENT	A
	SF Floor NW 3.5mm	3.5	US CEMENT	A
	HOSPILEUM NW	2.0	US CEMENT	A
	CHEMICAL-RESISTANT SUPER K SHEET NW	2.0	EPOGREY S	A
	CHEMICAL-RESISTANT SUPER K SHEET EXCELLA NW	2.0	EPOGREY S	A
	NS AQUATREAD	2.0	EPOGREY S	A
	NS REAL DESIGN NW	2.5	EPOGREY S	A
	FACTLEUM	2.0	EPOGREY S	A
	NS FLATY	2.0	EPOGREY S	A
	BATHNA ARTI	2.8	BATHNA CEMENT EPO	A
	BATHNA FLORE	3.5	BATHNA CEMENT EPO	A
	BATHNA REAL DESIGN	3.5	BATHNA CEMENT EPO	A
	Vinyl tile	CARESAFE NW	4.5	US CEMENT
MATURE NW		2.0	US CEMENT	B
FLOORLEUM PLAIN/MARBLE NW		2.0	EPOGREY S	C
FLOORLEUM Premier NW series *1		2.0	EPOGREY S	C
MATICO V		2.0	EPOGREY S	S
E-CLEAN NW-EX		3.0	EPOGREY S	S
TOUGHTEC TILE		3.0	EPOGREY S	S
STRAINE		3.0	EPOGREY S	S
ROYAL WOOD/ROYAL STONE		3.0	EPOGREY S	S
FASOL PLUS		3.0	EPOGREY S	S
Others	Linoleum	2.5	US CEMENT	A

### Adhesives

**EPOGREY S:**Epoxy resin based solvent type. Excellent durability to rolling loads.

**EPOGREY SS:**Epoxy resin based solvent type. For HITOE series. Excellent durability to rolling loads.

**US CEMENT:**Urethane resin based solvent type. One liquid chemical reaction type.

**BATHNA CEMENT EPO:**Epoxy resin based solvent type. Adhesive for BATHNA FLORE, BATHNA ARTI, and BATHNA REAL DESIGN

\*1: series consists of FLOORLEUM SOILUD NW, LATTICE NW, FLAKE NW, NATTY NW.

●If installed on underlay sheet, durability against rolling loads will be deteriorated and the products will not achieve above evaluation.

### [Criteria for Evaluation]

S and A are regarded as durable floorings against rolling loads.

Rank	Test results
S	Time until swelling is more than 30 minutes (2nd stage test by wheels of 46mm dia. Non-foamed sheet with backing)
A	Time until swelling is less than 30 minutes (2nd stage test by wheels of 46mm dia.)
B	Time until swelling is more than 60 minutes, less than 180 minutes (1st stage test by wheels of 110 mm dia.)
C	Time until swelling is less than 60 minutes (1st stage test by wheels of 110mm dia.)

### ● Test Method

Caster rolling test (JIS A 1454): as the 1st stage test

Set the specimen platform which moves back and forth, right and left directions (Figure 1). Let the pressure caster draw swivel trajectory (Figure 2) by the movement of the specimen platform. Evaluate by the time until the specimen is swelled or damaged.

Loading: 2000N (approx. 204kgf, approx. 900N/ cm<sup>2</sup>)

Caster: Iron, 110mm dia., 50mm width

Substrate: Fiber-reinforced cement board, 10mm thickness

Independent test by TOLI: as the 2nd stage test

Conduct tougher test by changing to smaller caster in case the test result of 1st stage is "more than 180 minutes".

Caster: Iron, 46mm dia., 20mm width

Load per unit area: approx. 2700N/cm<sup>2</sup> (approx. 280kgf/cm<sup>2</sup>)

Fig.1

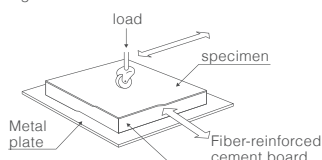
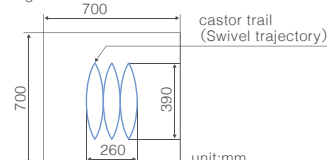

Fig.2



### ● Guide for Evaluating the Data

Roll the caster on the specimen with specified load. **If the time until floor gets swelled is longer**, it has better durability to rolling loads.

### ● Rolling loads onto floorings

	Total weight	Grounding area (cm <sup>2</sup> )	Load /cm <sup>2</sup>
Wheeled chair (with 4 rubber casters)	87kg	1.1 x 4 wheels	200N /cm <sup>2</sup>
Wheeled chair (with 5 plastic casters)	98kg	0.7 x 5 wheels	280N /cm <sup>2</sup>
Motorized operating Table	680kg	2.0 x 4 wheels	850N /cm <sup>2</sup>
Electric care bed	191kg	1.3 x 4 wheels	370N /cm <sup>2</sup>
Bath stretcher	115kg	1.3 x 4 wheels	220N /cm <sup>2</sup>
Shower chair	67kg	1.0 x 4 wheels	160N /cm <sup>2</sup>
General wheel chair (Steel, 24inch, pneumatic tire)	79kg	1.8 x 2 wheels + 6.1 x 2 wheels	50N /cm <sup>2</sup>
Electric wheel chair	114kg	2.5 x 2 wheels + 4.3 x 2 wheels	80N /cm <sup>2</sup>

\*All the testing was conducted by TOLI's in-house labs unless otherwise specified. The data shows actual test results, not guaranteed value.



# Durability against static loads



Use below data as a performance index to judge the durability against static loads of heavy equipment.

When furniture or equipment are removed after they are left for a long period of time, we find indent in some cases. Durability to static load indicates how resilient each floor covering is. In general, soft-surface floorings tend to have low recovery from indentation.

## Vinyl Sheets & Tiles

The less indentation means the better durability against static load.

Category	Product name	Thickness (mm)	Indentation (mm)	Evaluation
Vinyl sheet	Deodorant NS TOWARE NW	2.0	0.03	A
	HITOE GRANZA	2.0	0.04	A
	NONWAXLEUM NW (TS7000's)	2.0	0.04	A
	CHEMICAL-RESISTANT SUPER K SHEET NW	2.0	0.05	A
	New STANLOAD	2.0	0.04	A
	NONWAXLEUM NW (TS5000's)	2.0	0.06	A
	CHEMICAL-RESISTANT SUPER K SHEET EXCELLA NW	2.0	0.06	A
	NS AQUATREAD	2.0	0.06	A
	HITOE FINE	2.0	0.07	A
	NS FLATY	2.0	0.08	A
	BATHNA ARTI	2.8	0.08	A
	OPELEUM	2.0	0.09	A
	HOSPILEUM NW	2.0	0.10	A
	MATURE NW	2.0	0.11	B
	FLOORLEUM Premier NW series *1	2.0	0.11	B
	SF FLOOR NW	2.8	0.12	B
	BATHNA FLORE	3.5	0.12	B
	CARESAFE NW	4.5	0.12	B
	SF FLOOR NW 3.5mm (made to order)	3.5	0.14	B
	BATHNA REAL DESIGN	3.5	0.14	B
FLOORLEUM PLAIN/MARBLE NW	2.0	0.15	B	
SF FLOOR NW + Underlay sheet	7.3	0.21	C	
HOSPILEUM NW + Underlay sheet	6.5	0.39	D	
Vinyl tile	LOOSELAY MASTER NW-EX	5.0	0.06	A
	E-CLEAN NW-EX	3.0	0.07	A
	TOUGHTEC TILE	3.0	0.02	A
	STRAINE	3.0	0.11	B
	ROYAL WOOD	3.0	0.07	A
	FASOL PLUS	3.0	0.08	A
	LL FREE 40NW-EX	4.0	0.08	A
	LL FREE 50NW-EX	5.0	0.08	A
Others	MATICO V	2.0	0.10	A
	Linoleum	2.5	0.09	A

\*1: series consists of FLOORLEUM SOILUD NW, LATTICE NW, FLAKE NW, NATTY NW.

## Carpet Tiles

Category	Product name	Thickness (mm)	Evaluation
Carpet tile	GA-8900 + Underlay sheet for carpet tiles	10.0	a
	GA-100 + underlay sheet for carpet tiles	10.5	a
	GA-8900	6.0	a
	GA-100	6.5	a
	CORENTEV GX-9300V	6.5	a

### Vinyl Sheets & Tiles

[Criteria for Evaluation]

Rank	Indentation (mm)
A	≦ 0.1
B	0.1 <, ≦ 0.15
C	0.15 <, ≦ 0.3
D	0.3 <

● Guide for Evaluating the Data

The less indented depth indicates the better durability against static load.

\*TOLI conducts the test according to JIS, and evaluate by indented depth to indicate its conspicuous level.

● Test Method

Indentation Test B (in accordance with JIS A 1454)

Use the residual indentation tester with the attachment (steel stick with 19mmφ hemispherical tip which can put 222N load) and press the flooring for 5 mins. Measure the thickness at 60 mins. after removing the load, and compare with the thickness before testing.



Example of Indentation

### Carpet Tiles

[Criteria for Evaluation]

Rank	
a	Highly durable
b	Durable
c	Ordinary

● Guide for Evaluating the Data

The less % of reduced thickness indicates the better durability.

● Test Method

Reduced thickness test by static loads (JIS L 1021-6 /long time/heavy weight)

Measure the initial thickness before loading, then put 700kPa load on the specimen by static loading device for 24hours. Measure the thickness 24 hours after removal. Following equipment are used for this testing.

Measuring instrument: to measure the thickness in accuracy of 0.1mm, with disk pressurizer sized from 300mm<sup>2</sup> to 1000mm<sup>2</sup>, with specified standard ability of pressuring 2.0kPa ±0.2kPa

Testing stand: Made of metal, 6mm thickness, capable to measure the specimen sized 100mm x 100mm.

Test machine for static indent load: Device with 2mm+ bigger than the pressurizer in radius, capable to put 700kPa on the specimen (Figure 1)

Fig. 1

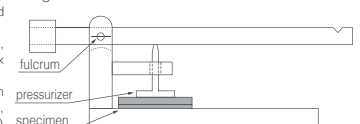

\*All the testing was conducted by TOLI's in-house labs unless otherwise specified. The data shows actual test results, not guaranteed value.





# Abrasion resistance



## of Vinyl Sheets, Tiles & Carpet Tiles

Use below data as a performance index to judge the durability against abrasion by walking with shoes.

The surface of floorings is abraded by traffic of walking and cart with casters. Sands brought by shoes from outdoor may also affect.

Abrasion will cause not only the damage of flooring, but also bad appearance by the dirt stuck on its surface, though it depends on traffic and maintenance.

### Vinyl Sheets & Tiles

Category	Product name	Thickness (mm)	Evaluation
Vinyl sheet	HITOE GRANZA	2.0	A
	HITOE FINE	2.0	A
	NONWAXLEUM NW (TS7000's)	2.0	A
	NONWAXLEUM NW (TS5000's)	2.0	A
	New STANLOAD	2.0	A
	MATURE NW	2.0	B
	HOSPILEUM NW	2.0	B
	FLOORLEUM PLAIN/MARBLE NW	2.0	B
	FLOORLEUM Premier NW series *1	2.0	B
	OPELEUM	2.0	B
	CHEMICAL-RESISTANT SUPER K SHEET NW	2.0	B
	CHEMICAL-RESISTANT SUPER K SHEET EXCELLA NW	2.0	B
	NS AQUATREAD	2.0	B
	NS FLATY	2.0	B
	SF FLOOR NW	2.8	B
SF FLOOR NW 3.5mm (made to order)	3.5	B	
CARESAFE NW	4.5	B	
Deodorant NS TOWARE NW	2.0	C	
Vinyl tile	MATICO V	2.0	B
	FASOL PLUS	3.0	B
	LOOSELAY MASTER NW-EX	5.0	B
	ROYAL WOOD / ROYAL STONE	3.0	C
	E-CLEAN NW-EX	3.0	D
	LOOSELAY 40 NW-EX	4.0	D
	LOOSELAY 50 NW-EX	5.0	D
Others	Linoleum	2.5	B

\*1: series consists of FLOOLEUM SOILUD NW, LATTICE NW, FLAKE NW, NATTY NW.

The less abrasion indicates high durability against abrasion.

### Carpet Tiles

Category	Product name	Thickness (mm)	Abrasion(mg)	Evaluation
Carpet tile	GA-8900	6.0	35.4	a
	CORENTE V GX-9300V	6.5	45.2	a
	DC-1100 (Dust Control)	10.0	54.3	a
	GA-100	6.5	70.4	a

\*BCF Nylon has superior durability against abrasion.

### Vinyl Sheets & Tiles

[Criteria for Evaluation]

Rank	Result (rev.)	Guide for uses
A	≥ 15,000	Commercial Use (Heavy duty)
B	5,000~15,000	Commercial use on ground floor without entrance mat
C	2,000~5,500	Commercial use on ground floor with entrance mat
D	≤ 2,500	Commercial & Residential use

#### ● Guide for Evaluating the Data

**Bigger number of effective abrasive revolution** indicates stronger abrasion resistance. Categorized into A, B, C & D based on each test result.

#### ● Test Method

Abrasion resistance test (JIS A 1454)

Maximum number of revolution = wear layer/abraded depth x 1,000rev. Drop sand on the specimen fixed on the revolving plate. Rotate 1,000 rev. with the abrasion of steel plate, steel brush, and tapping tool as attachments. Compare the thickness before and after testing.

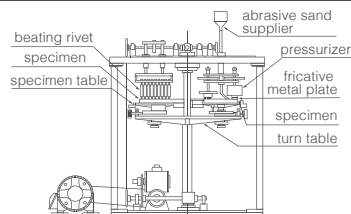

### Carpet Tiles

[Criteria for Evaluation]

Rank	
a	Highly durable
b	Durable
c	Ordinary

#### ● Guide for Evaluating the Data

The less abraded weight is, the more durability the pile has.

#### ● Test Method

Abrasion resistance test (JIS L 1021-11)

Put the wheel-shaped weight abraders on the circular specimen of 130mm diameter and rotate the specimen table. Measure the weight decreased by abrasion through rotational motion.

Weight: 1kg/wheel  
Rev.: 1,000

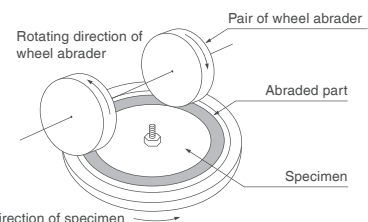

\*All the testing was conducted by TOLI's in-house labs unless otherwise specified. The data shows actual test results, not guaranteed value.



# Caster-moving smoothness of Vinyl Sheets, Tiles & Carpet Tiles

Use below data as a performance index to compare the smoothness of moving wheeled equipment.

Caster-moving smoothness contributes to the ease of moving stretcher, catering cart, wheel chair & bed with casters, and so forth. It is affected by the size and material of casters, and the resilience of floor coverings. Casters can move smoothly on the harder and less resilient surface of the flooring.

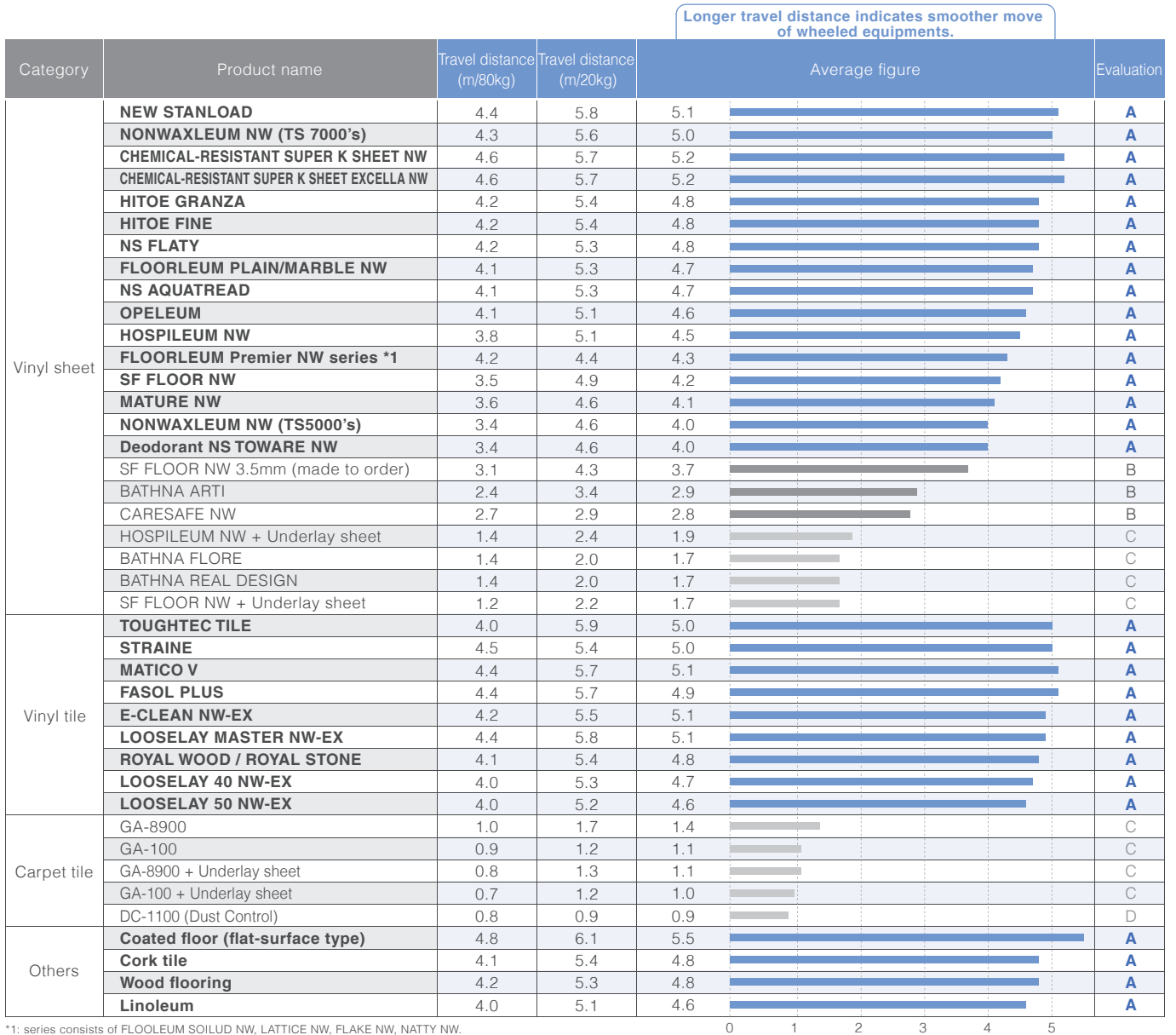

\*1: series consists of FLOOLEUM SOILUD NW, LATTICE NW, FLAKE NW, NATTY NW.

[Criteria for Evaluation]

Rank	Test Result	Guide for uses
A	≧4.0	Can move with a little strength
B	≧2.0	Can move with a pushing strength
C	≧1.2	Continuous strength is needed to keep moving
D	<1.2	Need strong strength to move

● Test Method

Caster-moving smoothness test (Independent test by TOLI)  
 Let the loaded cart with casters move down a slope of about 10 degrees' inclination. Measure the travelling distance of the cart from the edge of horizontally-laid floor covering to the center point of rear casters of the cart after it has stopped. On the assumption of actual usage, the cart is loaded with 20kg or 80kg, and floor carpet tiles are installed in quarter turn. (See Fig. 1)

● Guide for Evaluating the Data

Caster running smoothness is good when **running distance is long**.

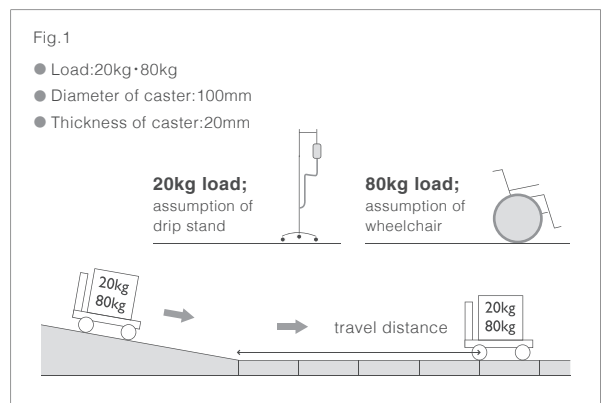

\*All the testing was conducted by TOLI's in-house labs unless otherwise specified. The data shows actual test results, not guaranteed value.



# Noise reduction & Sound-Insulation Properties



of Vinyl Sheets, Tiles & Carpet Tiles

Use below data as a performance index to consider in reducing the noise caused by walking or falling objects.

Noise level by walking or dropping something on floor is shown by the Impact Sound Level. Usually the rooms floored by carpet or PVC sheet with cushioning effect will generate less impact sound to offer quiet surroundings.

Category	Product name	Thickness (mm)	Bigger value means the better noise reduction.	
			Sound reduction (dB)	Evaluation
Vinyl sheet	CF SHEET-SD	3.5	22.2	A
	CF SHEET-H	1.8	14.9	B
	CARESAFE NW	4.5	14.3	B
	HOSPILEUM NW + Underlay sheet	6.5	14.0	B
	CF SHEET-P NW	2.3	10.6	B
	SF FLOOR NW + Underlay sheet	7.3	13.2	B
	NS REAL DESIGN NW	2.5	9.2	B
	SF FLOOR NW 3.5mm (made to order)	3.5	9.1	B
	SF FLOOR NW	2.8	8.9	B
	HOSPILEUM NW	2.0	6.1	C
	NS SHEET NS800	2.5	5.7	C
	FLOORLEUM PLAIN/MARBLE NW	2.0	3.0	D
Vinyl tile	LOOSELAY 50 NW-EX	5.0	4.7	C
	ROYAL WOOD / ROYAL STONE	3.0	1.8	D
	MATICO V	2.0	1.5	D
Carpet tile	<b>GA-100</b>	6.5	22.0	A
	<b>GA-8900</b>	6.0	21.4	A
	<b>GA-100 + Underlay sheet</b>	10.5	21.4	A
	<b>GA-8900 + Underlay sheet</b>	10.0	17.0	A
Others	Cork	5.0	7.0	C
	Linoleum	2.5	3.6	D
	Wood flooring	12.0	2.0	D
	Concrete	-	0	D

## [Criteria for Evaluation]

Rank	Noise generation	Sound reduction (dB)	
A	↑	≥15	Sounds like noise is reduced to half
B	Not easy	7-15	Sounds like some noise is reduced
C	Easy	4-7	Sounds like noise is not reduced much
D	↓	<4	Sounds like almost no noise reduction

## ● Guide for Evaluating the Data

Sound reduction is shown by improvement (dB) in the chart.

The **bigger value shows** the better sound reduction due to floor covering.

Compared with the walking sound by high-heeled shoes on concrete slab of 74.2 dB & 1000Hz as main frequency, describe the sound reduction on each flooring.

## ● Test Method

Measuring sound-reduction level (Independent test by TOLI)

Tapping machine sound of 1000Hz is measured by noise meter. Read the difference of noise level by tapping concrete slab and the flooring on the slab.

Instruments: Tapping Machine, Hammer: weighs 520g with 3cm diameter.

Tap height: 4cm, Microphone distance from the tapping machine 2M (horizontal), 1.5M (vertical).



Testing device by TOLI R&D

\*All the testing was conducted by TOLI's in-house labs unless otherwise specified. The data shows actual test results, not guaranteed value.